

# MS24S SLIMLINE HOUSING

## Military Qualified 2x4 GPS Splitter

### DESCRIPTION

The MS24S is a military qualified, two-input, four-output, GPS splitter that includes an antenna health sensor and embedded antenna switch. Dual input ports allow the splitter to be connected to two GPS receive antennas. The sensor monitors the health of the primary antenna connected to the splitter. Based on the information provided by the sensor, the splitter will switch to the secondary antenna in the event of a failure with the primary antenna. The embedded switch has been designed so it can be controlled externally. This external control can also override the internal automatic switch.

The MS24S can eliminate the need for multiple GPS antennas on the surface of a roof or other platform, as four RF output ports allow the MS24S to distribute (split) the signal to multiple devices. Redundancy is acquired through the use of a primary antenna and a backup antenna. The ability of the MS24S to switch antennas, allows all connected GPS devices to remain fully functional in the event of an antenna failure. It has a thinner profile and is lighter in weight than the standard MS24. As with all splitters available from GPS Source, passive, amplified, or custom gain can be configured for the device.

### FEATURES

- Embedded Antenna Health Sensor
- Automatic Internal Antenna Port Switch
- External Antenna Port Switching Capability
- Passes GPS L1/L2, GLONASS L1/L2, Galileo, Compass
- Thin Profile for Tight Spots

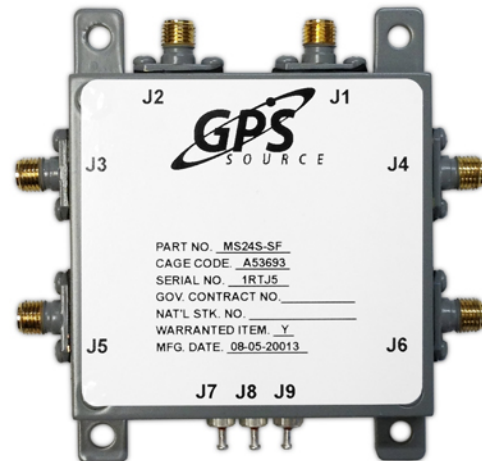

The MS24S is for military applications and environments where high reliability is required. It has been designed to the following MIL standards.

MIL Standards		
MIL-STD-810G	MIL-STD-883	MIL-STD-1587
MIL-STD-1472	MIL-E-5400	MIL-STD-461F
MIL-STD-202	MIL-HDBK-454	

### OPTIONS

The MS24S splitter comes with many available options to meet specific needs. Please contact GPS Source via phone, fax, email, or visit the website for further information on product options and specifications.

# 1. MS24S Specifications

## 1.1 Electrical Specifications

Table 1-1. Operating Temperature -40°C to 85°C

Parameter		Conditions	Min	Typ	Max	Units
<b>Frequency Range</b>		Ant: Any Port; Unused Ports: 50Ω	1		1.7	GHz
<b>Gain</b>	Amplified (Normal)	Ant: Any Port; Unused Ports: 50Ω	6	8	10	dB
	Amplified (Custom)	As Specified (xdB, from 0 to 8dB)	X - 2	X	X + 2	dB
<b>Loss-Passive</b>		Ant: Any Port; Unused Ports: 50Ω	8	9	10	dB
<b>Input SWR</b>		All Ports 50Ω			2:1	—
<b>Output SWR</b>		All Ports 50Ω			2:1	—
<b>Noise Figure-Amplified</b>		Ant: Any Port; Unused Ports: 50Ω, Gain = 8dB			4.3	dB
<b>Gain Flatness</b>	Amplified	[L1 – L2] Ant: Any Port; Unused Ports: 50Ω			2	dB
	Passive				1	dB
<b>Amp. Balance</b>		[J3 – J6] Ant: Any Port; Unused Ports: 50Ω			0.5	dB
<b>Phase Balance</b>		Phase (J3 – J6) Ant: Any Port; Unused Ports: 50Ω			1	Degree
<b>Group Delay Flatness</b>		$T_{d,max} - T_{d,min}$ ; J3 – J1 (Ant) or J3 – J2			1	ns
<b>Isolation</b>	Amp/Pass (Norm) (Gain = 8dB)	Opposite Ports: Ant – 50Ω Adjacent Ports: Ant – 50Ω	20 12			dB
	Amp (Hi Iso.) (Gain = 0dB)	Opposite Ports: Ant – 50Ω Adjacent Ports: Ant – 50Ω	38 28			dB
<b>Output <math>I_{P3}</math> (Amplified)</b>		Ant: Any Port; Unused Ports 50Ω, Gain = 8dB, Tone Spacing = 1MHz	12			dBm
<b>Output <math>P_{1dB}</math> (Amplified)</b>		Ant: Any Port; Unused Ports 50Ω, Gain = 8dB	0			dBm
<b>DC IN</b>	DC Blk	Any DC Blocked Port with a 200Ω Load			12	VDC
	Pass DC Amplified/Passive	Non-Powered Configuration, DC Input on J3	3.1		12	VDC
<b>Current (<math>I_{internal}</math>)</b>		Current Consumption of device (excludes Ant. Cur.)		25	30	mA
<b>Ant/Thru Current</b>	Pass DC	Non-Powered Configuration, DC Input on J3			250	mA
<b>Max RF Input</b>	Amplified	Max RF Input Without Damage			20	dBm
	Passive				40	dBm

## 1.2 Antenna Control Specifications

Antenna control can be automatic with manual override.

**Automatic Control (Default Option)** — The automatic control will automatically select the primary or alternate antenna based on the fault status of the two antennas. The fault status is determined by the current draw of the antennas. A current draw below 12.5mA and above 120mA will signal a fault at the respective input port. The fault condition will cause the device to automatically switch to the other input port.

### 1.2.1 Antenna Status and Control

The antenna status is available to an external application via a signal conveyed through the feed thru connector. The signal enables the external application to identify the antenna selected. By default, the Antenna Status signal will be HIGH if the primary antenna is selected and LOW if the alternate antenna is selected.

The secondary antenna is selected by pulling the antenna's control line to ground through a control such as an open collector/open drain output.

**Table 1-2. Antenna Control and Status Specifications**

Parameter	Conditions	Min	Typ	Max	Units
Antenna Control	V <sub>LOW</sub>	0	0.5	1	VDC
	V <sub>HIGH</sub>	3		12	
Antenna Status	V <sub>LOW</sub>	0	0.2	0.5	VDC
	V <sub>HIGH</sub>	3		12	
	I <sub>SINK</sub>			10	mA

### 1.2.2 Antenna Power and Ports

The desired antenna voltage is made available through a RF output port. J3 is usually configured as Pass DC. This configuration can pass the DC voltage available from a GPS device and power the receiving antennas, as well as, power the MS24S.

Note: Any DC blocked output port of the MS24S features an internal 200Ω load to simulate an antenna current draw. In the event of a fault at both the antenna input ports, the internal load opens up and flags the fault condition to the equipment to which it is connected.

**Table 1-3. Antenna Power Type and Associated Ports**

Power Type	Port	
Powered thru RF Out Coax	Input <sup>(1)</sup>	J1, J2 Pass DC
	Output	J3 Pass DC, J4, J5, J6, Block DC with 200Ω load

Note: 1. Input ports can be configured as Block DC upon request. If Primary antenna is chosen as Block DC, the external antenna control is required to switch the antennas.

### 1.2.3 MS24S Connector Option

Figure 1-1. Slimline Feed Thru Connectors

Pin	Description	Slimline Feed Thru Connectors <sup>(1)</sup>
J7	Signal Return	
J8	Antenna Switch Control	
J9	Antenna Switch Status	

Note: 1. Image is not to scale.

## 1.3 General Specifications

Table 1-4. General Specifications

Description		Measurement
Weight		0.7lbs (317g)
Mean Time Between Failure (MTBF)	Active Configuration	35,469 at 29°C
		31,739 at 71°C

## 2. Performance Data

### 2.1 MS24S — Passive

Figure 2-1. Passive MS24S Splitter Gain vs. Frequency

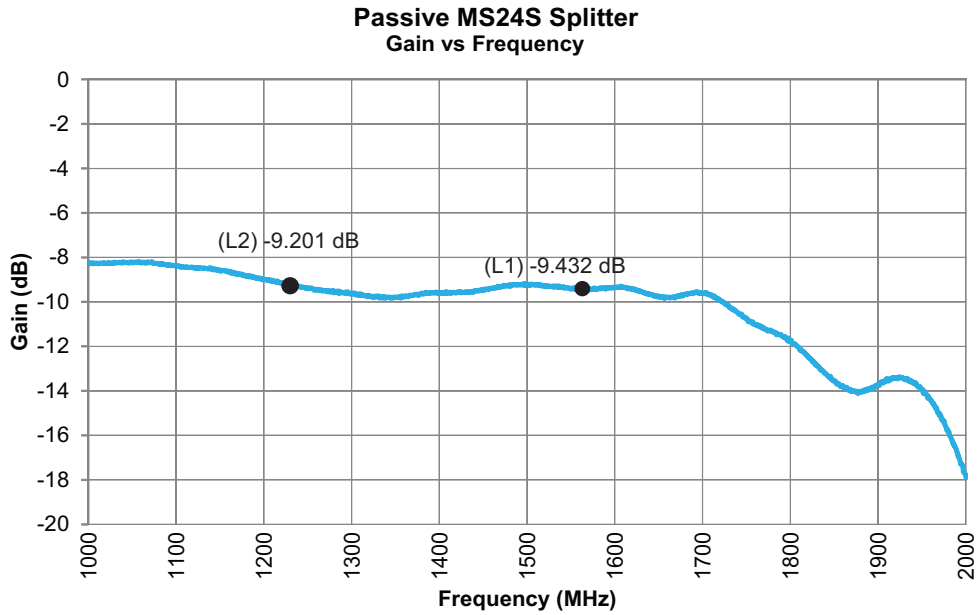
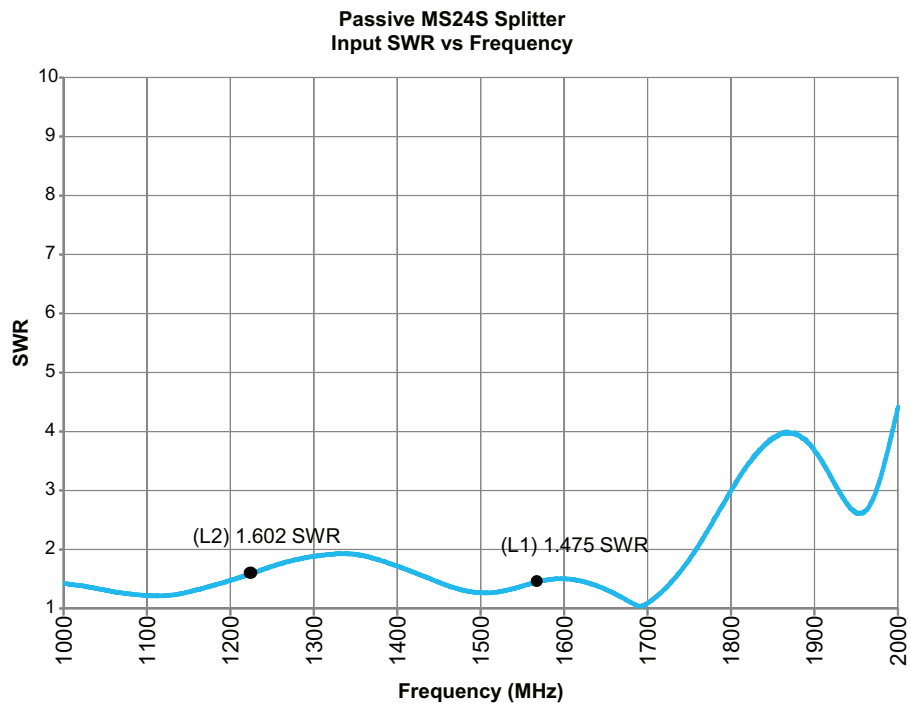

Figure 2-2. Passive MS24S Splitter Input SWR vs. Frequency



## 2.2 MS24S — Active

Figure 2-3. Active MS24S Splitter Gain vs. Frequency

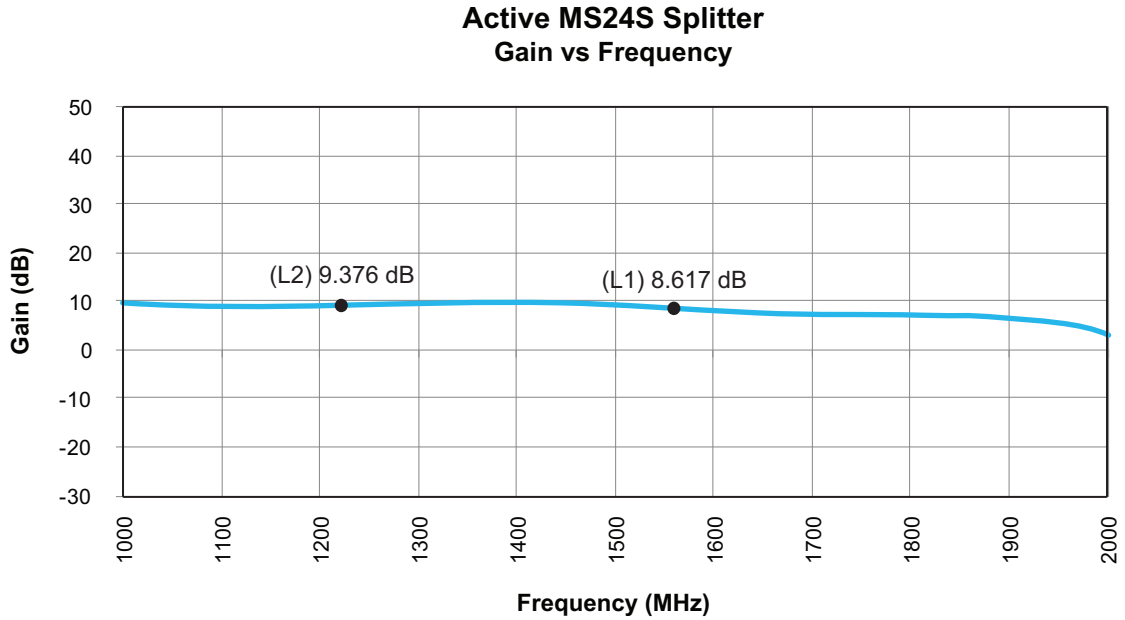
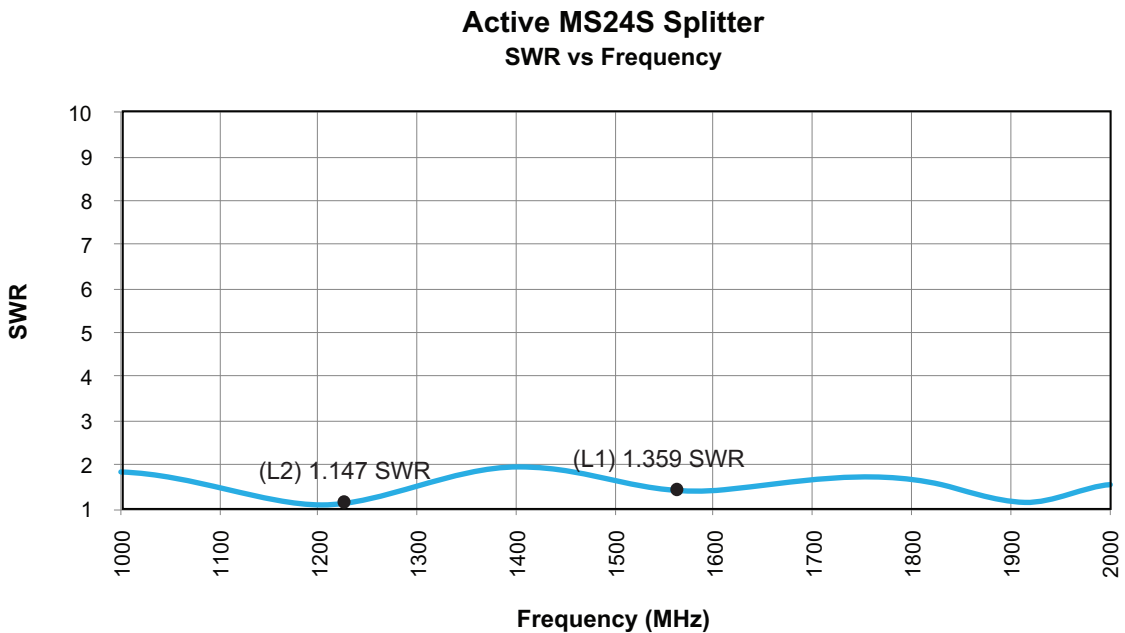

Figure 2-4. Active MS24S Splitter SWR vs. Frequency



## 3. Environmental Requirements

### 3.1 High and Low Temperature

The MS24S has been designed to comply with the temperature-altitude tests per MIL-STD-810G, Methods 501.5, 502.5, Procedure 1 and II.

- **High Temperature** (MIL-STD-810G, Mtd 501.5, Procedure I and II)

The MS24S is designed to operate without degradation in the temperature as defined in MIL-STD-810G, Mtd. 501.5, Procedure I and II for three cycles (24hr cycles over three days), climate category A1 Hot Dry Induced (storage and transit) conditions.

- Steady State High Storage Non-Operation Temperature: +71°C
- Steady State High Operating Temperature: +71°C

- **Low Temperature** (MIL-STD-810G, Mtd 502.5, Procedure I and II)

The MS24S is designed to operate without degradation in the temperature as defined in MIL-STD-810G, Mtd. 502.5, Procedure I and II, Cold (C2), Exposure duration a. (4 hours).

- Steady State Low Storage Non-Operation Temperature: -57°C
- Steady State Low Operating Temperature: -40°C

### 3.2 Temperature Shock

The MS24S is designed to operate without degradation during temperature shocks as defined in MIL-STD-810G, Mtd. 503.5, Procedure I-C (three cycles).

- T1: -15°C
- T2: +50°C
- Transfer Rate: Modified to 10 minutes.
- Ramp Rate: 6.5°C/min during cycles, <3°C/min to/from ambient.

### 3.3 Altitude

The MS24S is designed to operate without degradation during exposure to altitude as defined in MIL-STD-810G, Mtd. 500.5, Procedure II.

- Low Altitude: -400m MSL
- High Altitude: +9100m MSL

The MS24S is designed not to cause a materiel reaction that would endanger nearby personnel or the transportation platform during rapid decompression as defined in MIL-STD-810G, Mtd. 500.5, Procedure III.

- Descents Rate: 100 m/sec. over operational range defined above.

### 3.4 Explosive Atmosphere

The MS24S is designed for operation in the presence of explosive mixtures of air and jet fuel without causing explosion or fire at atmospheric pressures corresponding to altitudes from -1,800ft to 50,000ft. The MS24S does not produce surface temperatures or heat in excess of 400°F. The MS24S does *not* produce electrical discharges at an energy level sufficient to ignite the explosive mixture when the equipment is turned on or off or operated. The MS24S meets the requirements of MIL-STD-810G, Method 511.5, and Procedure II. The MS24S is designed to be intrinsically safe if possible, which then is exempt from the explosive atmosphere test.

---

### **3.5 Salt Fog**

The MS24S is designed to meet the requirements of Salt Fog conditions per Paragraph 3.2.24.9 of MIL-E-5400 and MIL-STD-810G Method 509.5. The MS24S is designed to withstand a salt concentration of five percent at a temperature of 35°C for 48 hours without degradation.

### **3.6 Fungus**

The MS24S is designed to meet the requirements MIL-STD-810G, Mtd 508.6, 28 days minimum. If all exposed materials are Group I, the fungus resistance requirement is met by analysis.

### **3.7 Humidity**

The MS24S is designed to withstand a 10 day humidity test conducted per MIL-STD-810G, Method 507.5; Procedure II. Tests consist of cycles with temperatures ranging from 24°C to 41°C and relative humidity ranging from 60% to 100% (non-precipitating) over a period of at least 10 days.

### **3.8 Sand and Dust**

The MS24S is designed to withstand the conditions of method MIL-STD-810G, Mtd 509.5, for a 5% concentration for a minimum of 48 hours.

### **3.9 Vibration**

The MS24S is designed to meet the requirements of random vibration per conditions (MIL-STD-810G, Method 514.6, Procedure 1).

### **3.10 Shock**

The MS24S is designed to meet the requirements of MIL-STD-810G Method 516.2 Proc. I and V.



### 3.11 Flammability

The MS24S is self-extinguishing or nonflammable and meet the Requirements of Paragraph 5.2.4 of MIL-STD-1587 and Requirement 3 of MIL-HDBK-454.

### 3.12 Finish and Colors

All case surfaces of the MS24S are treated with chemical film per MIL-DTL-5441, TYPE II, CLASS 3. The MS24S bottom contact surface is free of paint or non-conductive finishes. The MS24S bottom contact surfaces are protected from corrosion by a conductive coating (MIL-DTL-5541). All other surfaces, except connector mating surfaces are primed per MIL-PRF-23377, TYPE 1 CLASS C and painted per MIL-PRF-85285, TYPE 1 COLOR NUMBER (26231), Military Gray (not lusterless variety) per FED-STD-595 (Exceptions: bottom and connector surfaces are free of paint).

### 3.13 Human Factors

Human Engineering principles and criteria (including considerations for human capabilities and limitations) using MIL-STD-1472 are followed in all phases of design, development, testing, and procedures development. The design is free of all sharp edges, according to MIL-STD-1472.

### 3.14 Electromagnetic Interference and Compatibility Test

MS24S performs its intended function, and its operation does not degrade the performance of other equipment or subsystems. The MS24S is designed to meet the requirements of MIL-STD-461F:

**Table 3-1. Compatibility Test**

Test	Description
CE102	Conducted Emissions Power Leads 10kHz to 10MHz
CE106	Conducted Emissions Antenna Terminal 10kHz to 31.5GHz
CS101	Conducted Susceptibility Power Leads 30Hz to 150kHz
CS103	Conducted Susceptibility Antenna Port Intermodulation
CS114	Conducted Susceptibility Bulk Cable Injection 10kHz to 200MHz
RE102	Radiated Emissions Electric Field 10kHz to 18GHz
RS103	Radiated Susceptibility Electric Field 2MHz to 18GHz

### 3.15 Lightning and Surge

The MS24S is designed to withstand the following lightning electrical transients without permanent damage, system outages, or improper operation lasting beyond the transient period.

The transient is specified as a pin-to-case signal appearing at the equipment interface from a source impedance of  $20\Omega$ . Proper operation of the equipment shall be demonstrated with the equipment under test operating into actual or properly simulated interfacing circuits.

The transient is defined as a pin-to-ground (case or chassis) signal of either positive or negative polarity having electrical characteristics as follows:

The transient has a peak amplitude at the equipment connector pins of 800V (or 40A, whichever occurs first) from a source impedance of  $20\Omega$ . The transient, when feeding an open circuit load, is defined by the following equation.

The following are derived from the equation:

- $V_p = 800V$
- Time to first peak = 0.16psec
- Time for  $V_0$  to decay to  $1/e = 5psec$
- Damped wave basic frequency = 1MHz
- $dv/dt$  average for the rise to the first peak ( $V_p$ ) =  $5KV/\mu sec$
- Maximum energy to a matched load = 10mJ

The waveshape is shown below.

**Figure 3-1. Lightning Immunity Test Waveform**

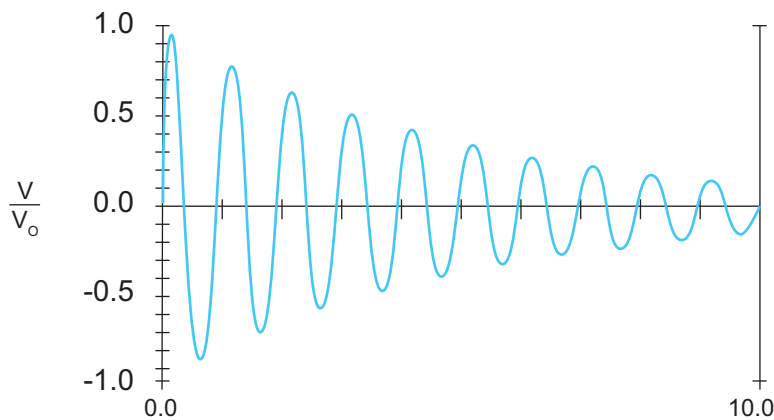

## 4. Product Options

Table 4-1. MS24S Available Options

RF Connector	Connector Type	Limitations
Connector	SMA (Male)	N/A

## 5. Product Code Decoder

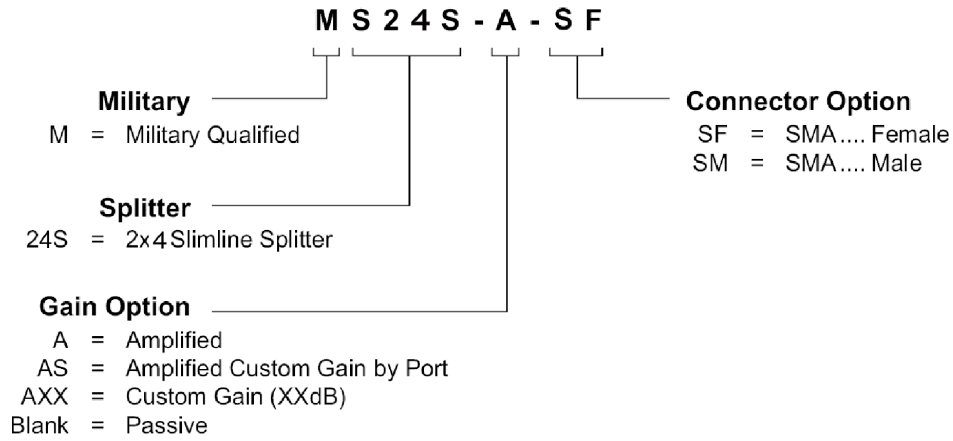

Note: To have product/part codes customized to meet exact needs, contact GPS Source at [techsales@gpssource.com](mailto:techsales@gpssource.com) or visit the website at [www.gpssource.com](http://www.gpssource.com).

## 6. Mechanical Drawing

### MS24S Slimline Housing — FSA-AFQ-CCX-AGZ

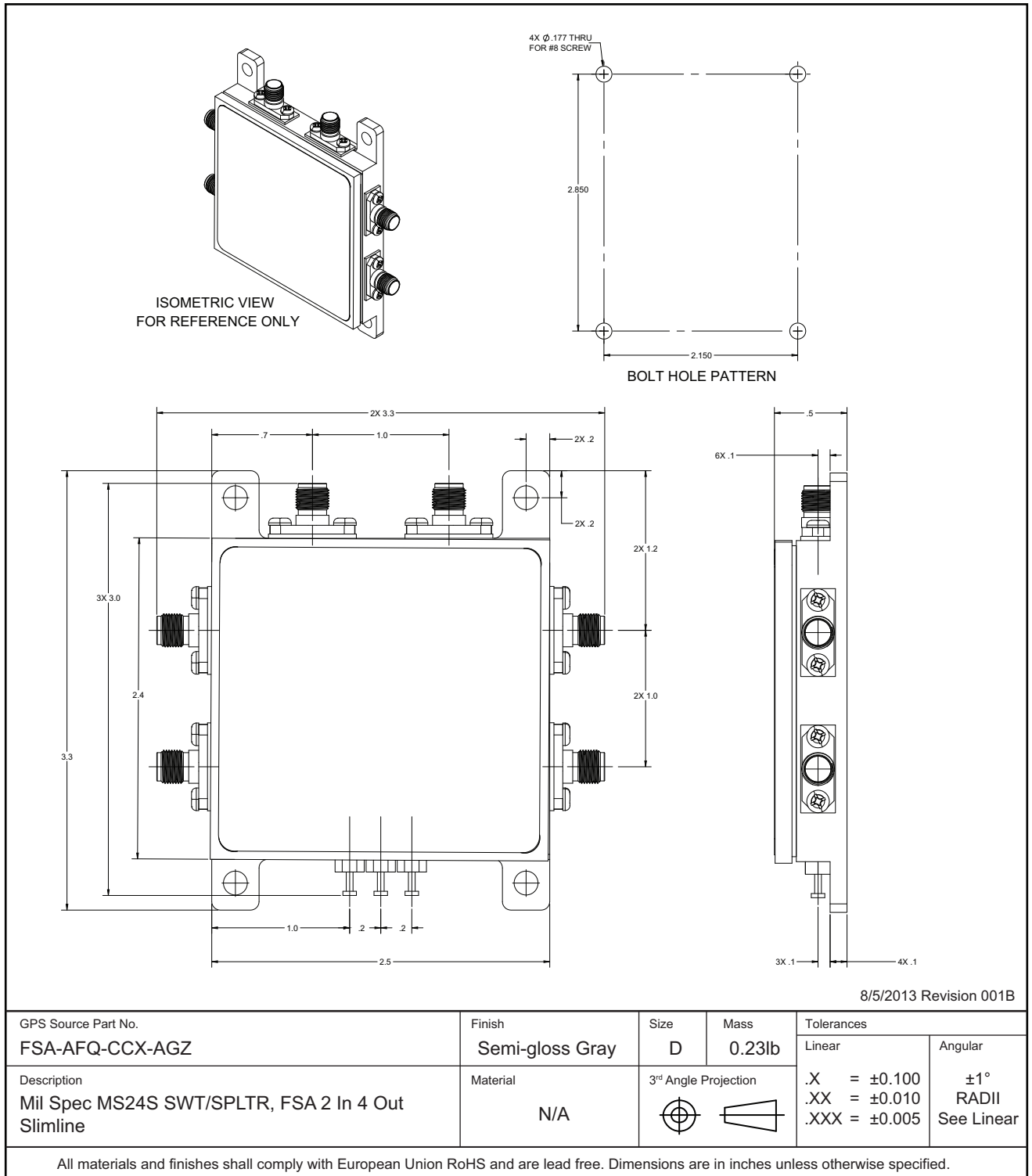





**gps LIVE INSIDE**

## **MS24S Slimline Housing Data Sheet**

059-FSA-AFQ-CCX-AGZ-003

Page 15 of 15, 11/26/2013

64 N. Mission Drive  
Pueblo West, CO 81007  
Phone: (+1)(719) 561.9520  
Fax: (+1)(719) 565.0890  
[techsales@gpssource.com](mailto:techsales@gpssource.com)  
[www.gpssource.com](http://www.gpssource.com)

AS9100C:2009 and ISO 9001:2008 Compliant Company



© 2013 GPS Source, Inc. All rights reserved.

GPS Source, Inc., GPS Live Inside, GPS Source logo, and other GPS Source, Inc. products, brands, and trademarks mentioned in this document are property of GPS Source, Inc. and/or its affiliates in the United States and/or other countries. Other products, brands, and trademarks are property of their respective owners/companies. Any rights not expressly granted herein are reserved.

DISCLAIMER: The materials in this document could include inaccuracies or typographical errors and are subject to change at any time. The materials are provided "as is" without warranty of any kind. To the maximum extent permitted by applicable law, GPS Source, Inc. and its suppliers hereby disclaim all warranties, either expressed or implied, and conditions with respect to the materials, their quality, performance, suitability, merchantability, fitness for a particular purpose, title, and non-infringement. LIMITATION OF LIABILITY: IN NO EVENT WILL GPS SOURCE, INC. AND ITS SUPPLIERS BE LIABLE FOR INDIRECT, SPECIAL, INCIDENTAL, OR CONSEQUENTIAL DAMAGES, WHETHER IN AN ACTION OF CONTRACT OR TORT, ARISING OUT OF THE USE OR INABILITY TO USE THE MATERIALS AVAILABLE IN THIS DOCUMENT, EVEN IF ADVISED OF THE POSSIBILITY OF SUCH DAMAGES. IN PARTICULAR AND WITHOUT LIMITATION, GPS SOURCE, INC. SHALL HAVE NO LIABILITY FOR ANY LOSS OF USE, DATA, INCLUDING THE COSTS OF RECOVERING SUCH DATA, OR PROFITS.