

**Intelligent GPS Splitter**

**DESCRIPTION**

The S14WI can eliminate the cost of multiple antennas and long cable runs in commercial or military GPS installations. It is a high performance, intelligent GPS signal splitter designed to meet the demanding reliability requirements of commercial and military applications. It can be configured to monitor the GPS antenna current and provide an alarm indication if the antenna is not operating according to specifications.

The S14WI features a standard antenna DC bias Pick-and-Choose circuit. This allows for the active antenna DC input to be applied to any or all RF outputs. With this feature, one DC voltage will be chosen to power the antenna while other inputs will be switched to DC loads. If the selected DC bias input should fail, the DC bias will automatically switch to another DC input to ensure an uninterrupted supply to the active antenna.

The S14WI is an amplified device with customer defined gain. This allows greater flexibility in optimizing performance for the application. It has an option for a GPS filter on the input. This offers excellent selectivity around the L1 band to prevent interference from other high power radio frequency sources. Surge protection is included on all five ports.

The S14WI is delivered in a sealed housing unit sufficient for many years of operation in demanding environments. The S14WI can be custom configured to fit unique infrastructure requirements. Please contact GPS Source for further information on product options and specifications.



**FEATURES**

- Amplified to Offset Splitter Losses
- Optional Antenna Current Monitor and Alarm
- Standard Antenna DC Bias Select
- Optional GPS Filter
- Pole-mount Environmental Housing Standard (IEC 529 level IP55)
- Surge Protection Standard (Tested to EN61000-4-5)

# 1 S14WI Electrical Specifications

**Table 1-1. Electrical Specifications**

Operating Temperature -40°C to 85°C

Parameter		Conditions	Min	Typ	Max	Units
<b>Frequency Range</b>		Ant: Any Port; Unused Ports: 50Ω <sup>(1)</sup>	1.2		1.7	GHz
<b>Bandwidth (3dB)</b>		Filtered Option	-15	1575.42	+15	MHz
		+/-50MHz, Ant Output		45		dB
<b>Gain<sup>(2)</sup></b>		Ant: Any Port; Unused Ports: 50Ω <sup>(1)</sup> (Gain can be customized from 0dB to 12dB)	8	10	12	dB
<b>Input/Output SWR</b>		All Ports 50Ω <sup>(1)</sup>			2.0:1	—
<b>Noise Figure</b>		Ant: Any Port; Unused Ports: 50Ω <sup>(1)</sup> , Gain = 10dB			2	dB
<b>Gain Compression Point (IP1dB)</b>	Filtered	1565MHz < f < 1585MHz	-35			dBm
		f < 1560MHz and f > 1591MHz	-25			dBm
	Unfiltered		-35			dBm
<b>3<sup>rd</sup> Order Intercept (IIP3)</b> (Gain = 10dB)	Unfiltered	f1 = 1600.42MHz f2 = 1625.42MHz 2f1 – f2 = fL1	-23			dBm
<b>RF Input (Damage Threshold)</b>		1575MHz +/-50MHz, Ant. Input			+10	dBm
<b>Amp. Balance</b>		[J1 – J2] Ant: Any Port; Unused Ports: 50Ω <sup>(1)</sup>			1	dB
<b>Phase Balance</b>		Phase (J1 – J2) Ant: Any Port; Unused Ports: 50Ω <sup>(1)</sup>			1	Degree
<b>Delay</b>		Ant: Any Port; Unused Ports: 50Ω <sup>(1)</sup> , L1			5	ns
<b>Isolation</b> (Gain = 10dB)		Adjacent Ports: Ant – 50Ω <sup>(1)</sup>	35			dB
		Alternate Ports: Ant – 50Ω <sup>(1)</sup>	44			dB
<b>DC IN</b>		DC Input on Any RF Output	4		12	VDC
<b>Out-to-IN V<sub>DROP</sub></b>		Antenna Current of 30mA			.5	V
<b>Device Current</b>		Current Consumption of Active Device (excludes Ant. Cur.)		18	20	mA
<b>Ant/Thru Current<sup>(3)</sup></b>		Max Source DC Current Through Device			250	mA
<b>Antenna Monitor<sup>(4)</sup></b>	I <sub>CC</sub>	Range for Open Circuit Threshold	10		25	mA
	I <sub>SC</sub>	Range for Short Circuit Threshold <sup>(5)</sup>	100		180	mA
<b>Surge Protection</b>		8/20μs		4		KA

- Notes:
1. If the desired custom gain is greater than 10dB, for proper RF performance, the S14WI should have all RF ports terminated into a 50Ω coaxial cable system or a 50Ω load.
  2. Custom gain option available (from 0dB to 21dB).
  3. Maximum current available from the DC source through the S14WI when output of S14WI is short circuited.
  4. Open and short circuit current (IOC, ISC) can be specified by the customer within the specified range.
  5. In-rush current shall not exceed 3A or exceed I<sub>SC</sub> for greater than 1ms.

## 2 Performance Data

### 2.1 Unfiltered

Figure 2-1. Unfiltered Frequency Response

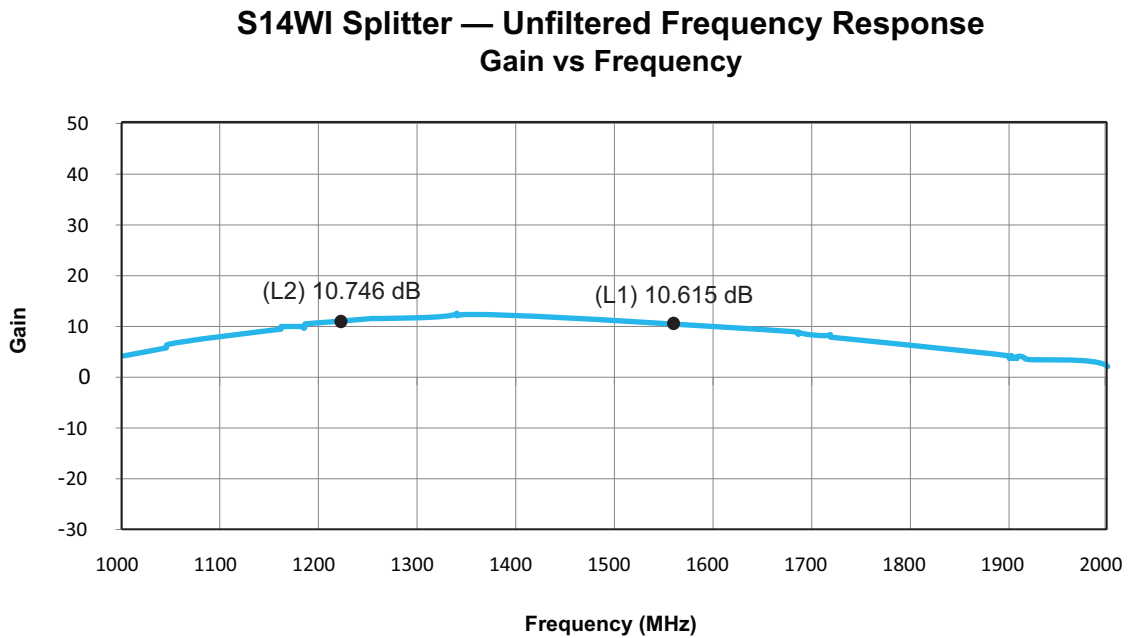

Figure 2-2. Unfiltered Input SWR

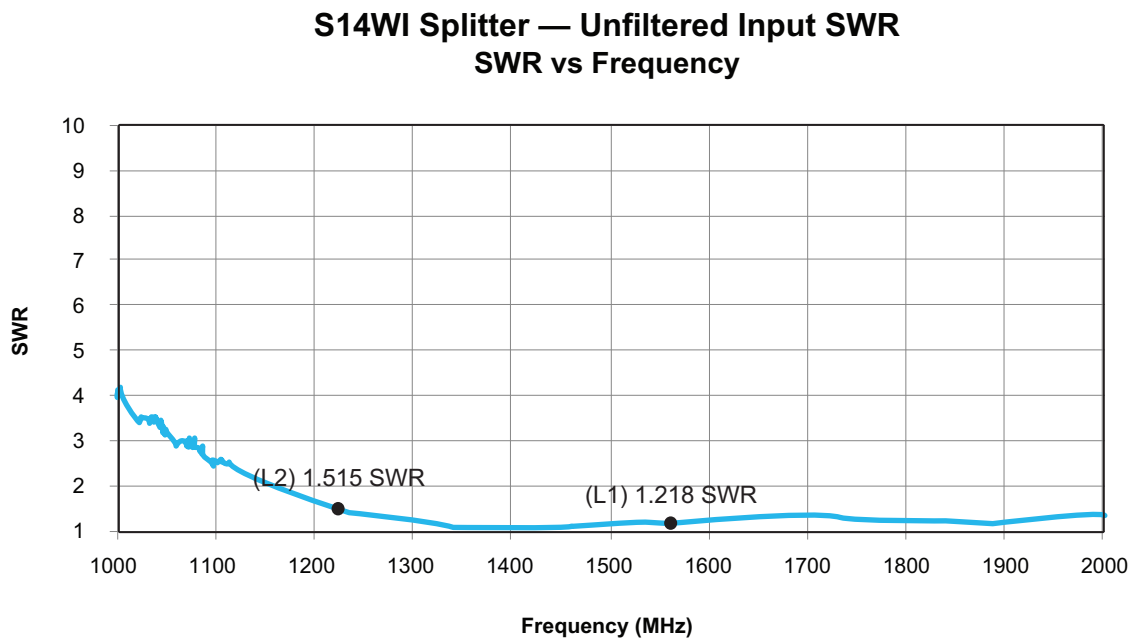

Figure 2-3. Unfiltered Output SWR

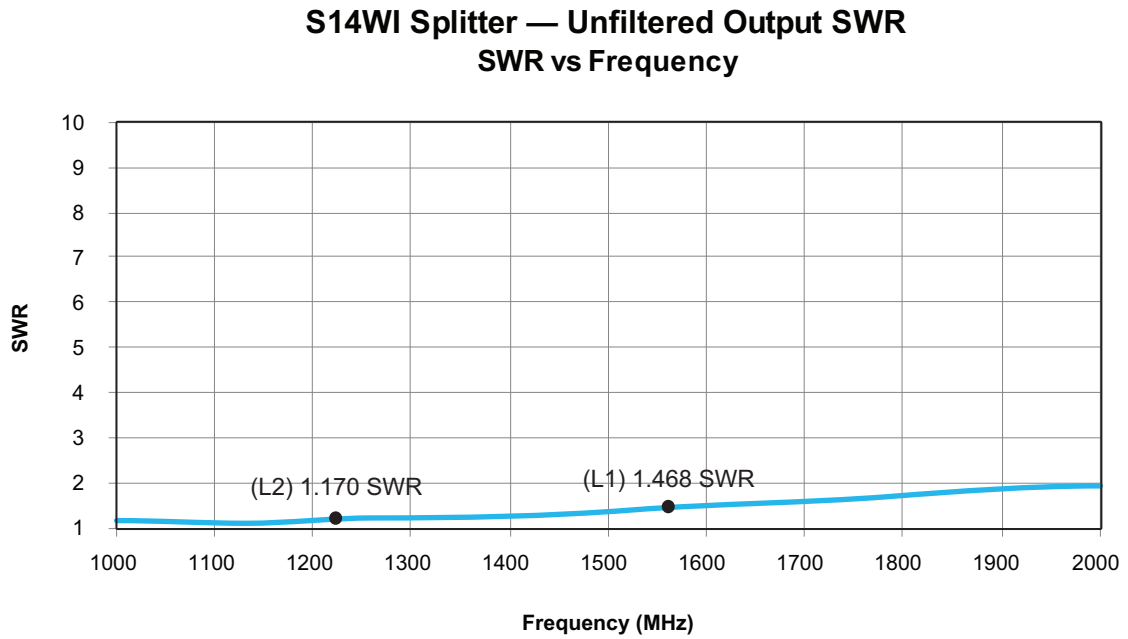
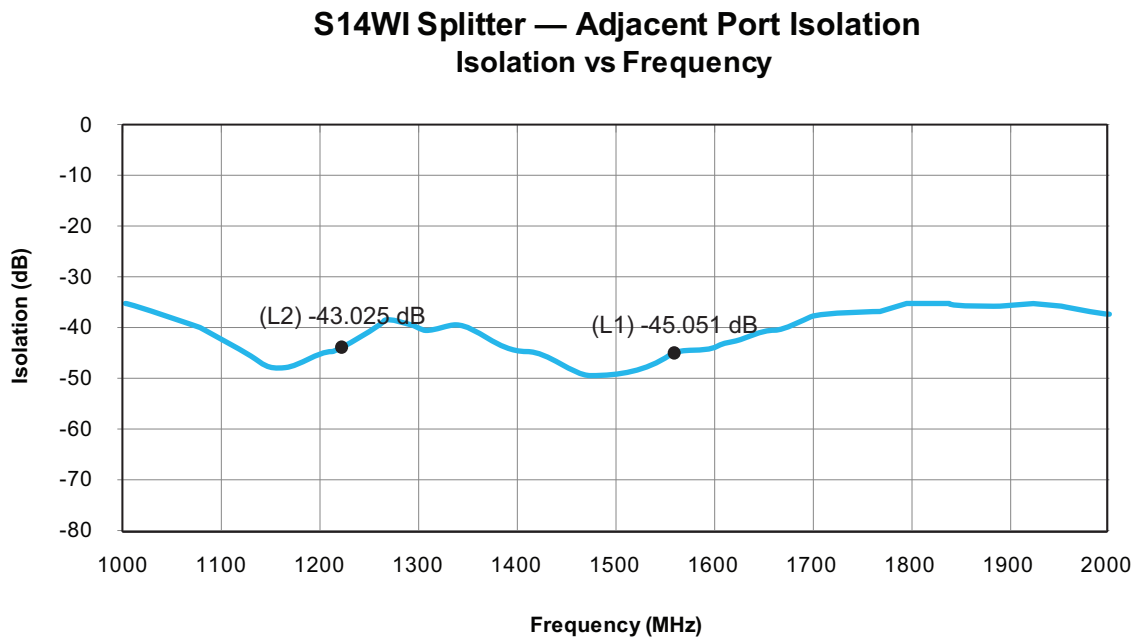

Figure 2-4. Adjacent Port Isolation



## 2.2 Filtered Option

Figure 2-5. Filtered Frequency Response

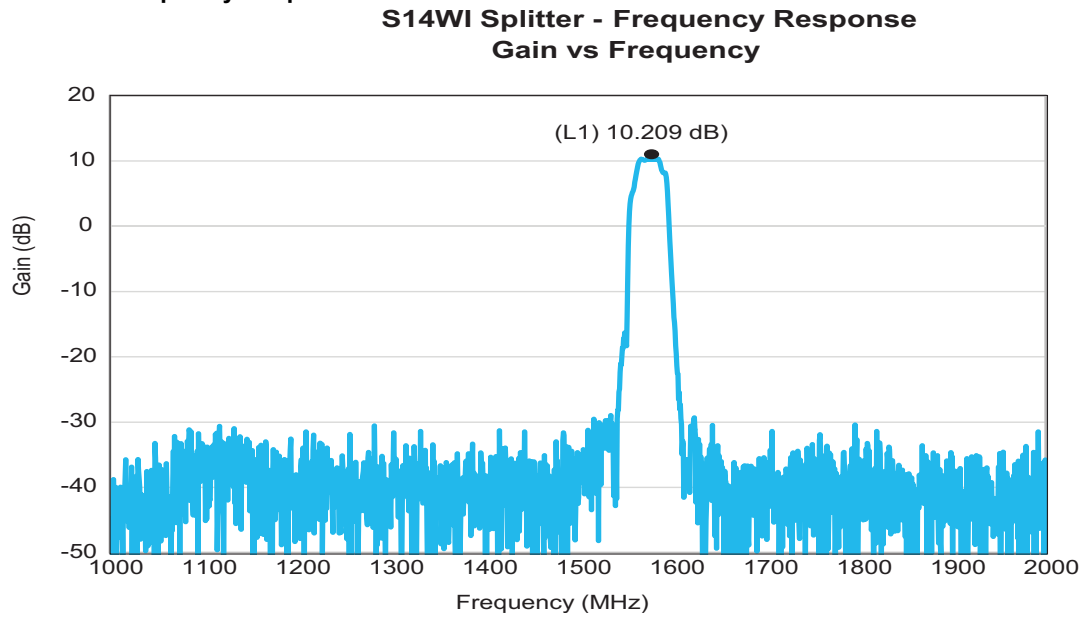

Figure 2-6. Filtered Frequency Response

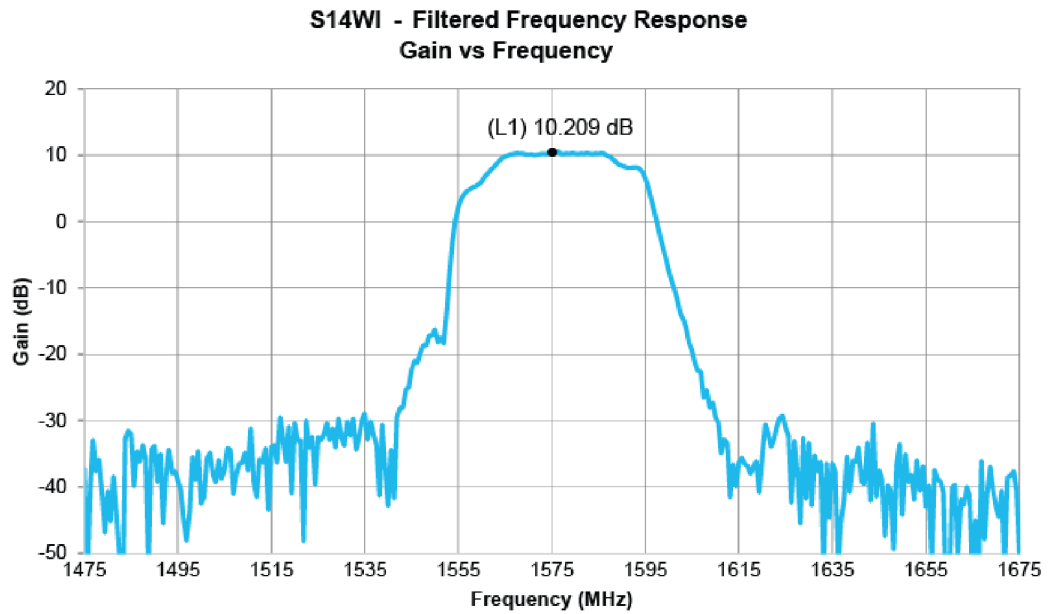
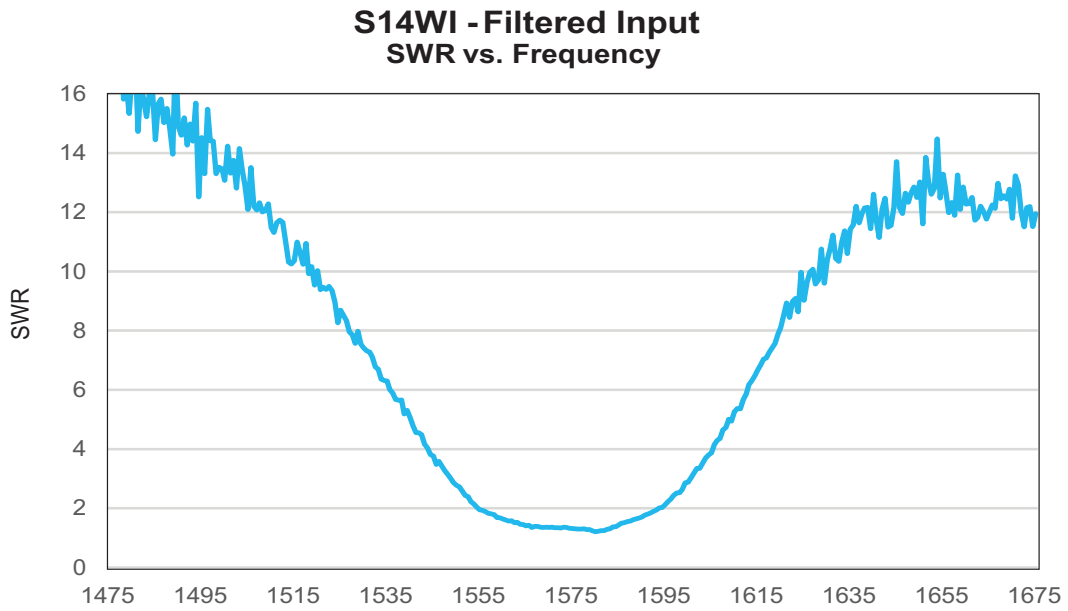

Figure 2-7. Filtered Input SWR



## 3 Operational Description

### 3.1 RF Signal Processing System

The RF signal processing system consists fundamentally of amplification stages and three classical Wilkinson Splitter elements which divide the RF signal from the antenna input evenly between four RF output ports. There are two options available concerning the RF Signal Processing System. These options are:

- Filtered
- Gain

### 3.2 Filtered Option

The S14WI is available with a filtered option which should be chosen if the S14WI is expected to operate in a severe EMI/EMC environment. The filtered option includes a low insertion loss pre-selection filter prior to the gain stages to protect the amplifiers from saturation and overload due to very strong out-of-band signals in the vicinity of the S14WI (e.g. Cellular or PCS cell towers). It includes a high rejection filter after the gain stages which further filter signals that are not strong enough to saturate the initial gain stages but can be strong enough to disrupt GPS signal processing in the application receivers downstream.

### 3.3 Gain Option

In the Amplified High Isolation Configuration (standard), 50 $\Omega$  signal attenuators are in the RF output paths to provide additional isolation between each RF port. The S14WI does not require 50 $\Omega$  terminations on unused ports in order for the splitter to operate correctly. This standard configuration is chosen if it is possible for spurious emissions from one GPS receiver on one port of the splitter to cause interference with GPS receivers connected to other output ports. The input port to any output port gain of the splitter is approximately 10dB. Additional attenuation will result in higher port to port isolation.

The S14WI gain can be specified by the customer to have any input-to-output gain from 0dB to 21dB. If necessary, the gain can be specified over this range independently for each individual port (e.g. The gain for ports 0, 1, and 2 can be specified to 0dB, while the gain for the remaining ports can be specified to 10dB).

To some extent, the port-to-port isolation performance is a function of the input-to-output gain. The port-to-port isolation is maximized when the gain is 0dB or lower.

### 3.4 Termination of Unused Ports

If the desired custom gain is greater than 10dB, all ports should be terminated with 50 $\Omega$  loads in order to ensure proper operation of the Wilkinson Splitter elements. If all ports are not terminated properly, the S14WI Input/Output SWR and Gain/Loss may not comply with specifications.

In the standard configuration, the 50 $\Omega$  signal attenuators provide substantial isolation from open circuits on unterminated output ports. Consequently, RF outputs can be left unterminated without adversely affecting the operation of the S14WI.

### 3.5 Antenna DC Bias Select

GPS Source RF signal splitters are unique relative to other generic RF signal splitters as they typically operate in conjunction with an active GPS antenna (a GPS antenna that includes an integrated Low Noise Amplifier). Consequently, a GPS RF signal splitter must have provisions for managing the DC voltage to the active GPS antenna.

The S14WI splitter requires a DC voltage be applied to one or more of the RF output ports by way of the RF connector center conductor. If DC voltages are applied to more than one of the RF output ports, the S14WI pick-and-choose circuit will choose one of these DC inputs to power the active circuitry of the S14WI and will also pass this DC voltage through the splitter to the center conductor of the RF input port. Ports without an external DC voltage applied, or from which an external DC voltage is removed, are internally pulled-down to ensure that the false input voltage indications do not occur. The DC voltage available on the RF input port can be used to power the application's active antenna.

The DC voltages applied to the RF outputs that are not chosen by the pick-and-choose circuitry will automatically switch through an RF choke to 200Ω DC loads. The pick-and-choose circuit will always select the DC voltage on the lowest numbered RF port that has a DC voltage applied to power the S14WI and the application's antenna. If the chosen DC input is removed or fails, the pick-and-choose circuit will automatically switch to the next higher numbered RF port to which a DC voltage is applied.

**Example 1:** Assume DC voltages are applied to RF outputs 1, 3, and 4. In this scenario, the DC voltage on port 1 will be used to power the S14WI and the application antenna. Ports 3 and 4 will be switched to 200Ω DC loads.

**Example 2:** Now assume the DC voltage on port 1 is removed. The S14WI will automatically terminate the input internally with a pull-down resistor and switch the operation of the splitter and antenna to the DC voltage applied to the next high numbered port with a DC voltage applied, port 3. Port 4 will remain switched to a 200Ω load.

### 3.6 Antenna Monitor and Alarm

The S14WI includes an option to monitor the status of the application's active antenna and to provide an alarm indication if the antenna's current is not within a specified range. The default current window for the S14WI is 10mA to 150mA (e.g. below 10mA indicates an open circuit, and above 150mA indicates a short circuit); however, for large volume orders, the antenna current window can be specified to meet the customer's specific requirements.

The S14WI samples the antenna current 16 times per second. As long as the average of four samples are within the current window, the S14WI will continue to operate normally, passing the DC voltage applied to lowest number RF output on to the RF input. In this mode, DC voltages applied to the remaining RF outputs are switched to 200Ω DC loads. If the average of four antenna current samples fall outside of the antenna monitor current window, the DC voltage to the antenna is removed (open circuit), and all DC inputs are switch to Pass DC; however, since the DC path to the antenna has been opened, the DC current on all four DC inputs will be less than 5mA. In this alarm condition, all GPS receivers connected to the RF outputs will also see very low antenna current draw, resulting in corresponding antenna alarm conditions within each receiver.

Once in the alarm condition, the S14WI will periodically (every 60 seconds) attempt to reconnect the DC power to the antenna. If the antenna failure condition persists, the S14WI will re-enter the fault condition, repeating this cycle until the fault condition is removed.

### 3.7 Surge Arrestor System

The S14WI includes standard Gas Discharge Tubes and Transient Voltage Suppressors on each RF input/output. Furthermore, provisions for high current grounding are included in the metal enclosure of the device. The Surge Arrestor System is intended to provide a limited capability to survive power line surges and voltage surges that can be induced by near miss lightning strikes. Protection is rated to 4KA, according the IEC-61000-4-5. In order to ensure proper protection of the device, the S14WI *must* be connected via a (8AWG minimum) ground cable to a low impedance ground.



## 4 S14WI Connection

o install the S14WI, connect the coaxial cable feeding the active GPS antenna prior to connecting the RF outputs. Once the antenna coaxial cable is attached, coaxial cables with or without DC voltages can be connected to the outputs.



At least one coaxial cable connected to any output of the device must provide a DC voltage suitable for operating the active GPS antenna and the S14WI.



In some instances, upon initial connection of the DC voltage, the S14WI may power-up in the Antenna Fault mode which will prevent the DC voltage from being applied to the active antenna.

If this behavior is observed immediately after power-up, wait for approximately one minute. Proper operation should be restored by this time. If after one minute proper operation is not observed, ensure a *known-good* active GPS antenna that sinks a DC current within the specified range is connected to the IN port of the S14WI via a *known-good* RF coaxial cable

## 5 Certifications and Approvals

Certifications and Approvals	
EMC/Emissions	FCC part 15B and R&TTE equivalent
Power Line Surge	IEC-61000-4-5
Safety/Low Voltage	EN60950-1
Environmental	IEC 60529, IP55

## 6 Product Code Decoder

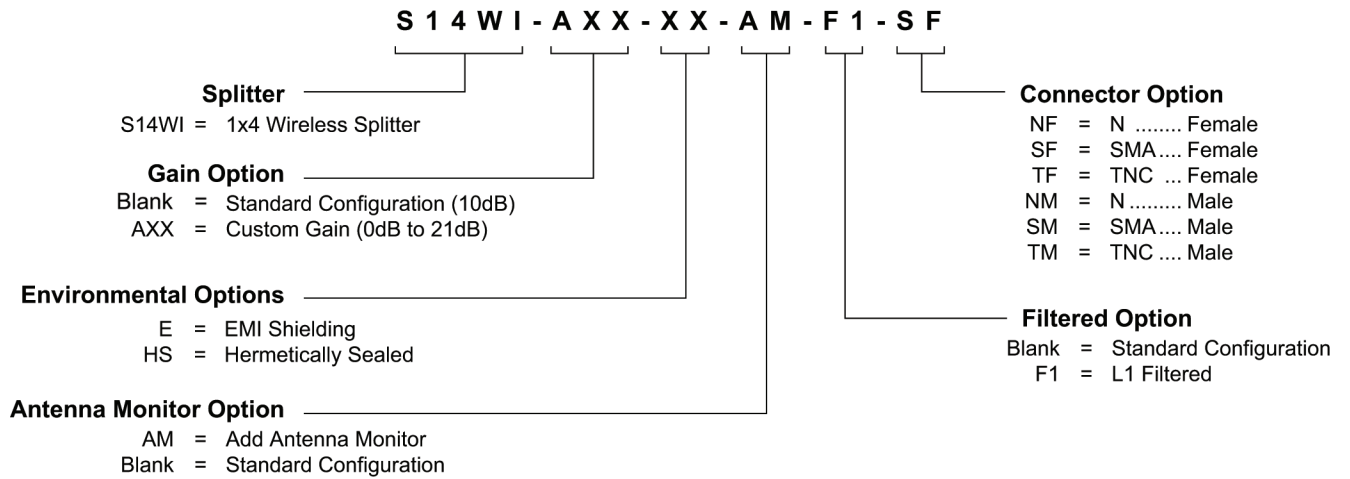

Note: To have product/part codes customized to meet exact needs, contact GPS Source at [techsales@gpssource.com](mailto:techsales@gpssource.com) or visit the website at [www.gpssource.com](http://www.gpssource.com).

# 7 Mechanical Drawing

## S14WI Intelligent GPS Splitter — FSA-AGQ-AAS-AGZ

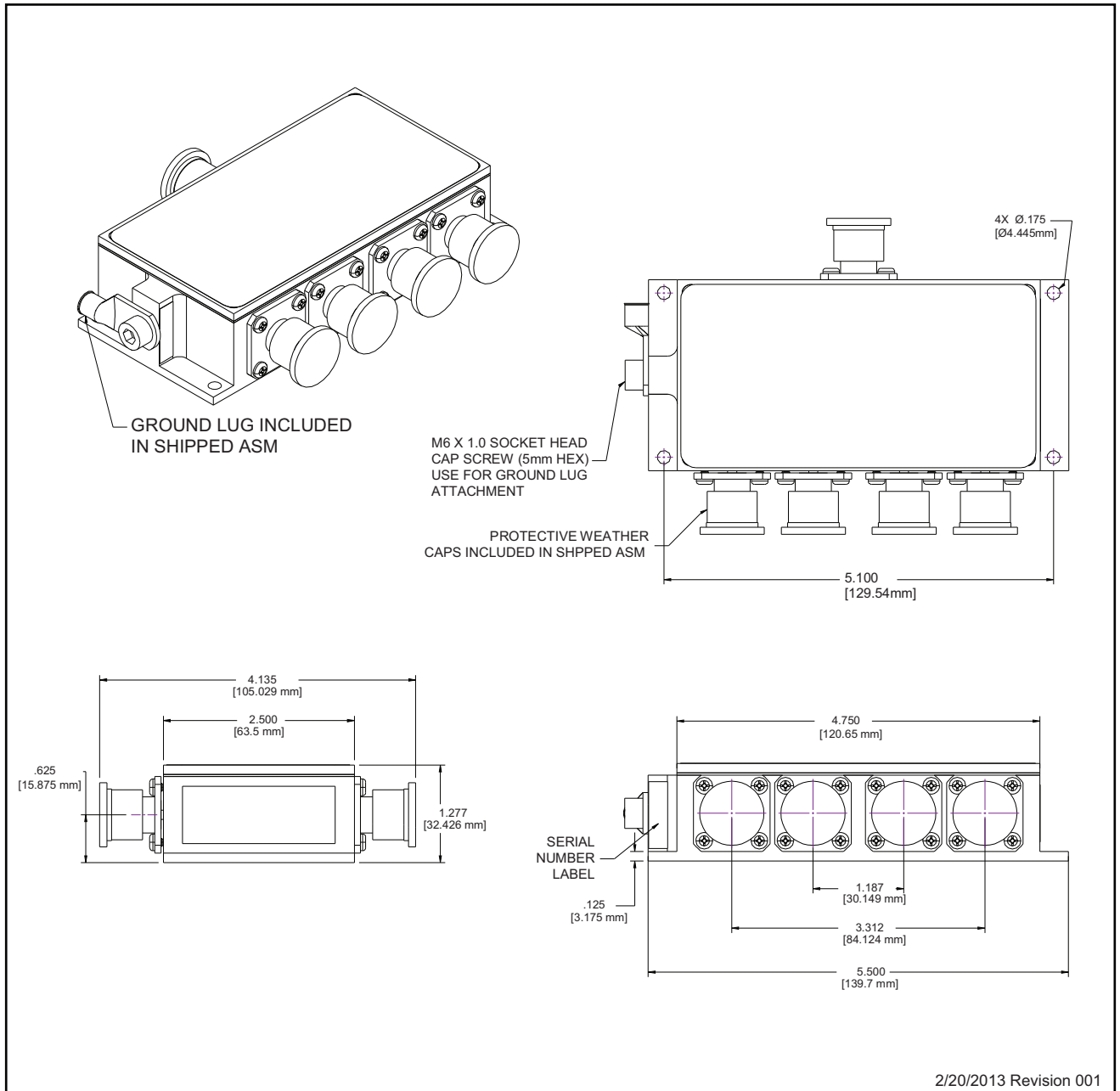

GPS Source Part No. <b>FSA-AGQ-AAS-AGZ</b>	Finish <b>N/A</b>	Size <b>C</b>	Mass	Tolerances	
Description <b>FSA-S14WI AMPLFD W/SRG SPPRSSN W/DC BIAS SEL W/O ANTENNA MNTR</b>	Material <b>N/A</b>	3 <sup>rd</sup> Angle Projection 		Linear <b>.X = ±0.100 .XX = ±0.010 .XXX = ±0.005</b>	Angular <b>±1° RADII See Linear</b>

All materials and finishes shall comply with European Union RoHS and are lead free. Dimensions are in inches unless otherwise specified.



**GPS LIVE INSIDE**

## **S14WI Intelligent GPS Splitter Data Sheet**

059-FSA-AGQ-AAS-AGZ-001

Page 12 of 12, 11/05/2013

64 N. Mission Drive  
Pueblo West, CO 81007  
Phone: (+1)(719) 561.9520  
Fax: (+1)(719) 565.0890  
[techsales@gpssource.com](mailto:techsales@gpssource.com)  
[www.gpssource.com](http://www.gpssource.com)

AS9100C:2009 and ISO 9001:2008 Compliant Company



© 2013 GPS Source, Inc. All rights reserved.

GPS Source, Inc., GPS Live Inside, GPS Source logo, and other GPS Source, Inc. products, brands, and trademarks mentioned in this document are property of GPS Source, Inc. and/or its affiliates in the United States and/or other countries. Other products, brands, and trademarks are property of their respective owners/companies. Any rights not expressly granted herein are reserved.

DISCLAIMER: The materials in this document could include inaccuracies or typographical errors and are subject to change at any time. The materials are provided "as is" without warranty of any kind. To the maximum extent permitted by applicable law, GPS Source, Inc. and its suppliers hereby disclaim all warranties, either expressed or implied, and conditions with respect to the materials, their quality, performance, suitability, merchantability, fitness for a particular purpose, title, and non-infringement. LIMITATION OF LIABILITY: IN NO EVENT WILL GPS SOURCE, INC. AND ITS SUPPLIERS BE LIABLE FOR INDIRECT, SPECIAL, INCIDENTAL, OR CONSEQUENTIAL DAMAGES, WHETHER IN AN ACTION OF CONTRACT OR TORT, ARISING OUT OF THE USE OR INABILITY TO USE THE MATERIALS AVAILABLE IN THIS DOCUMENT, EVEN IF ADVISED OF THE POSSIBILITY OF SUCH DAMAGES. IN PARTICULAR AND WITHOUT LIMITATION, GPS SOURCE, INC. SHALL HAVE NO LIABILITY FOR ANY LOSS OF USE, DATA, INCLUDING THE COSTS OF RECOVERING SUCH DATA, OR PROFITS.